

# The Soviet Lunar Landing Program

INST 154

Apollo at 50

[N1 Launches](#)

[LK Lunar Landing Animation](#)

Launch escape system

L3 Complex

BLOK G

BLOK V

BLOK B

BLOK A

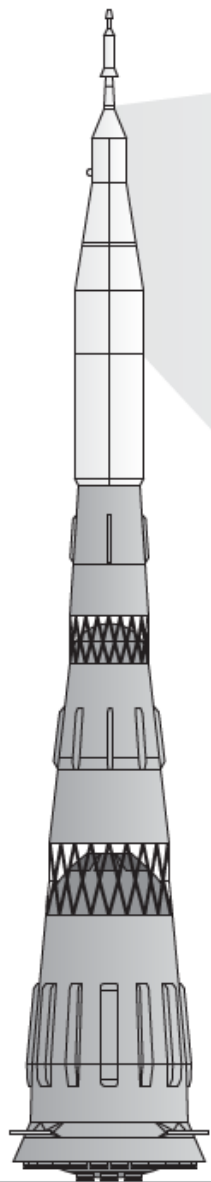

N1/L3

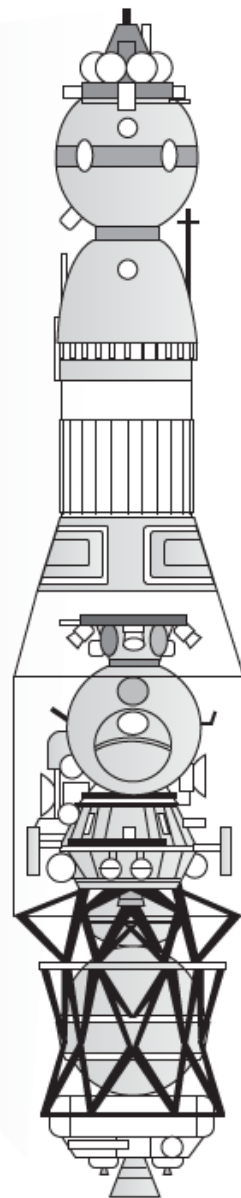

L3 Complex

Lunar Orbital Craft (LOK)

Lunar Craft (LK)

BLOK D

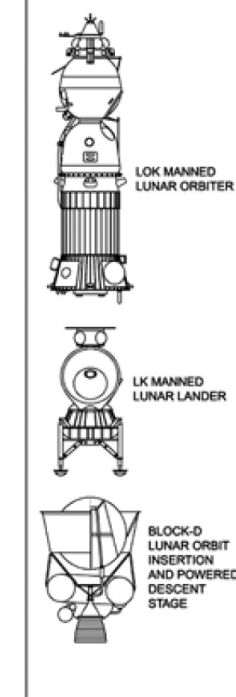
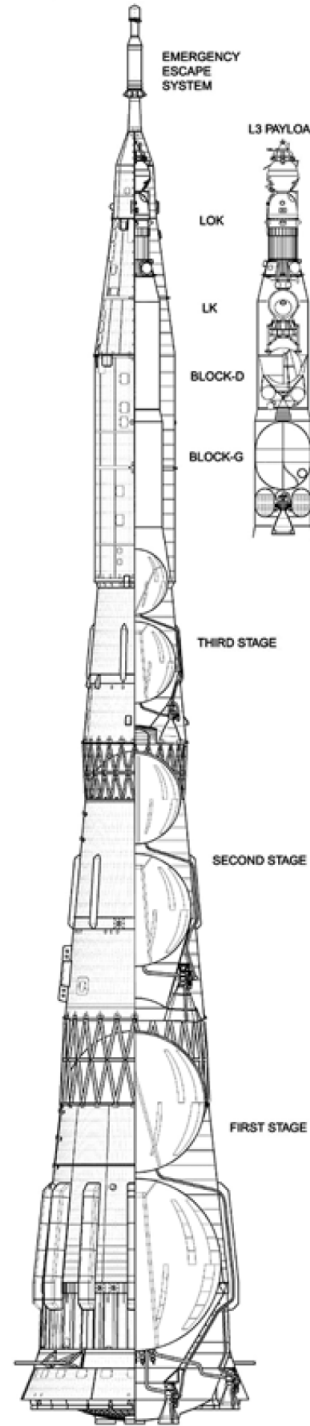

THIRD STAGE WITH 4 ENGINES

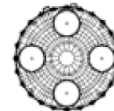

SECOND STAGE

SECOND STAGE WITH 8 ENGINES

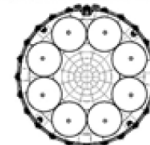

FIRST STAGE

FIRST STAGE WITH 30 ENGINES

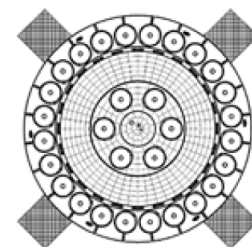



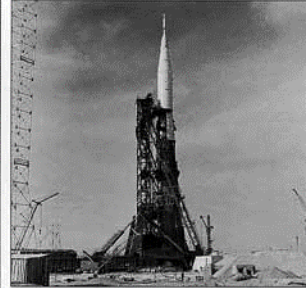
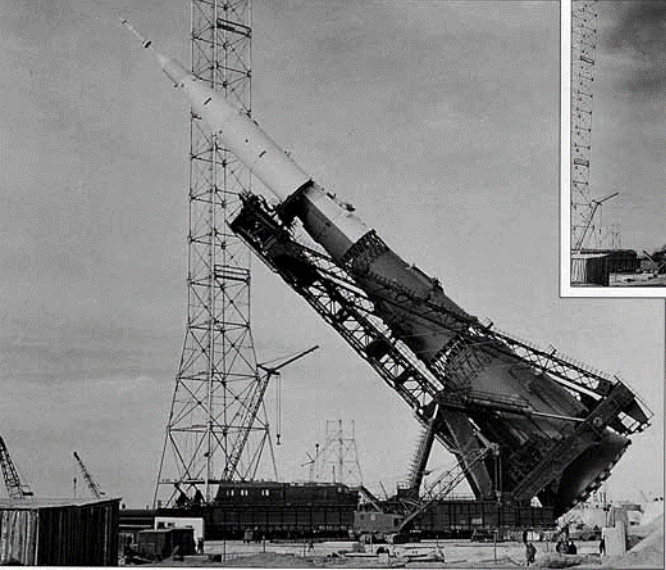

Система Н1-Л3 установлена вертикально на пусковом устройстве. Транспортно-установочное устройство не отведено

Установка системы Н1-Л3 на пусковом устройстве

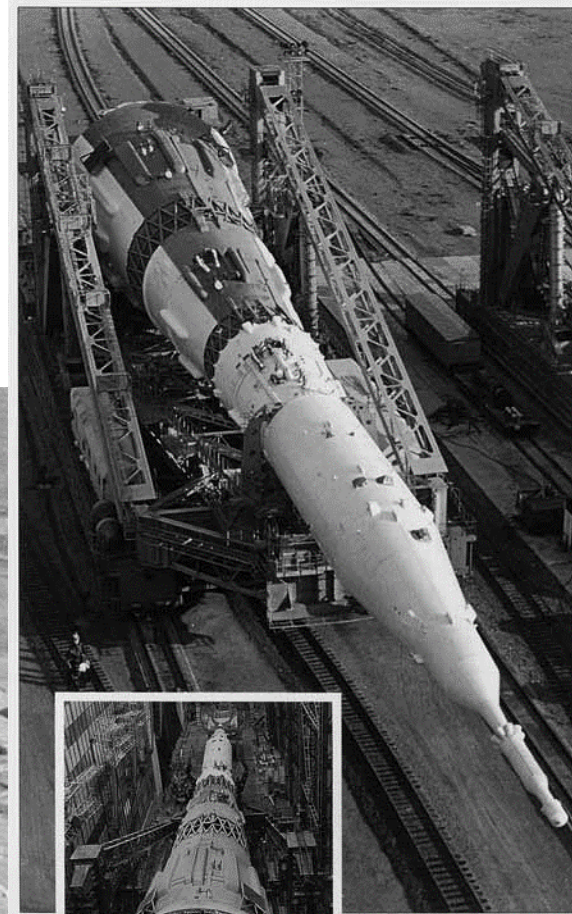
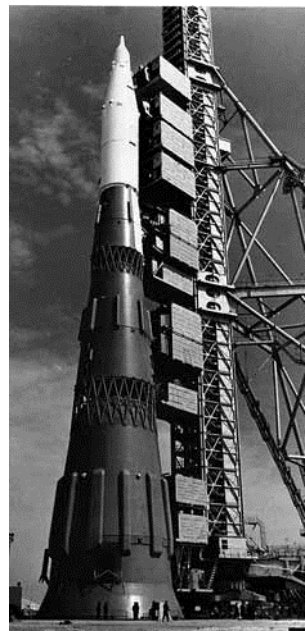

Система Н1-Л3 в пути на стартовый комплекс

Система Н1-Л3 около пускового устройства стартового комплекса

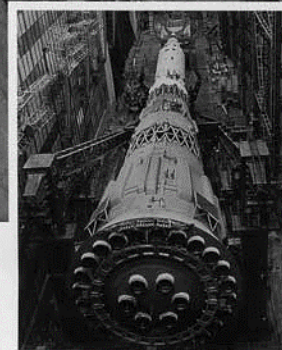

Космическая система Н1-Л3 на транспортно-установочном агрегате в монтажно-испытательном корпусе, готовая к вывозу на старт

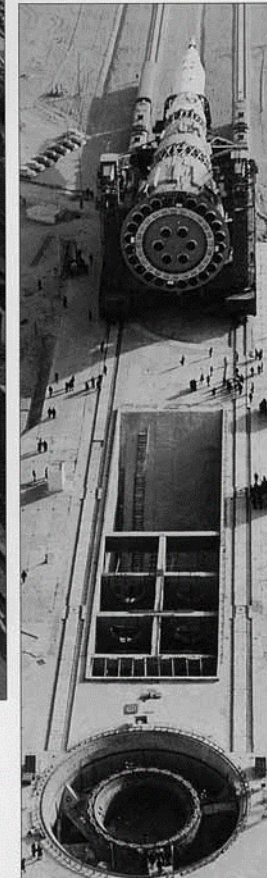



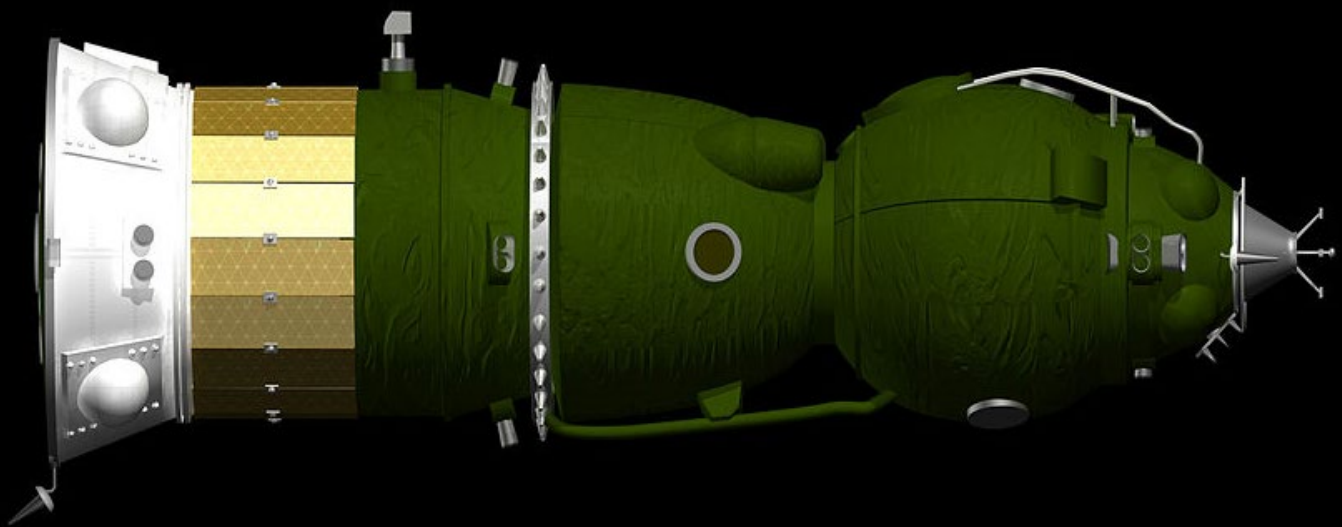
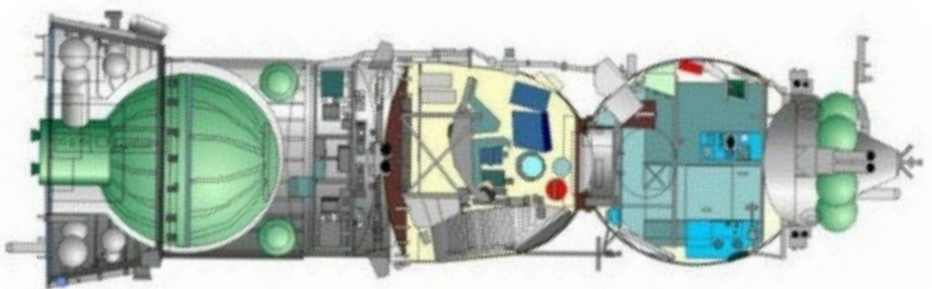

Fig. 1: Cosmonaut transfers from LOK to LK

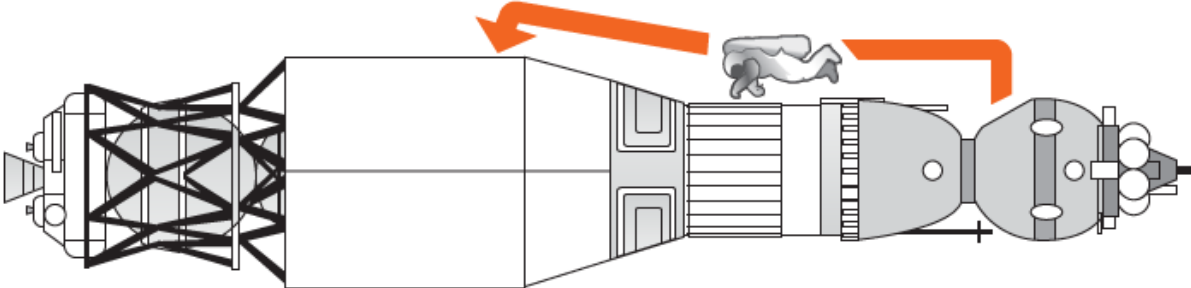
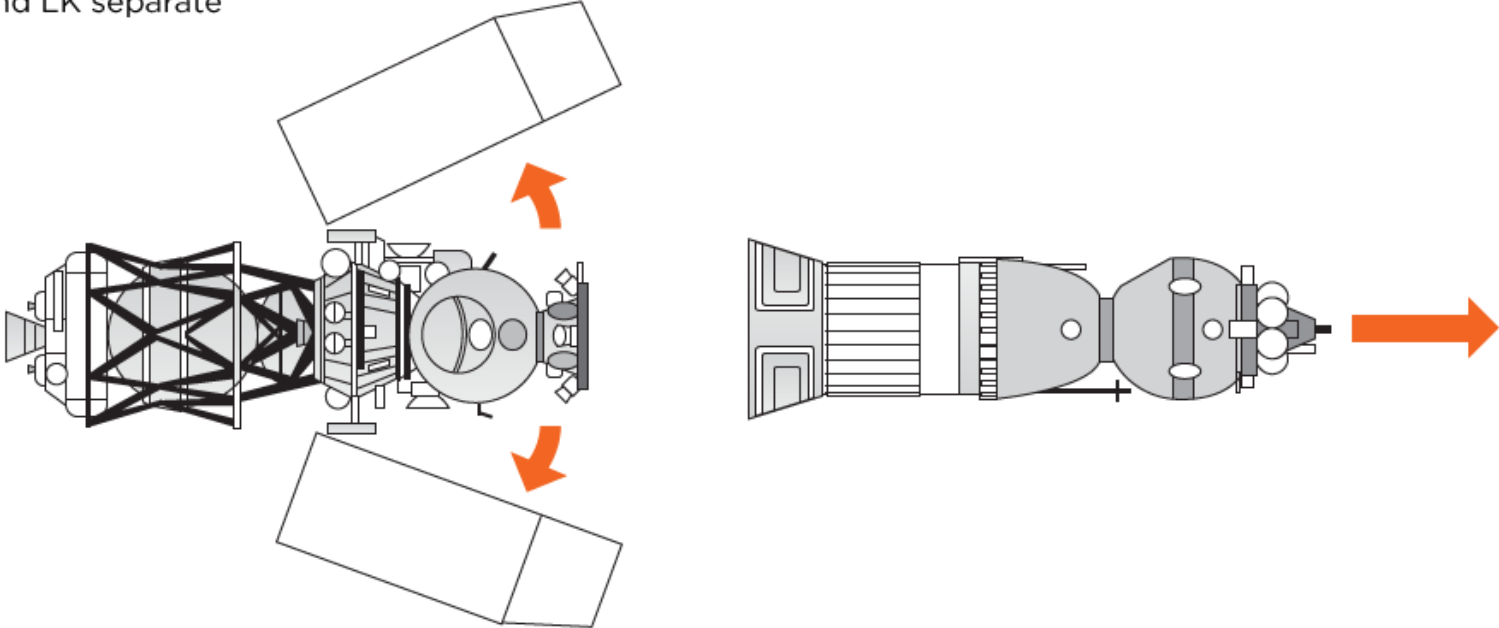
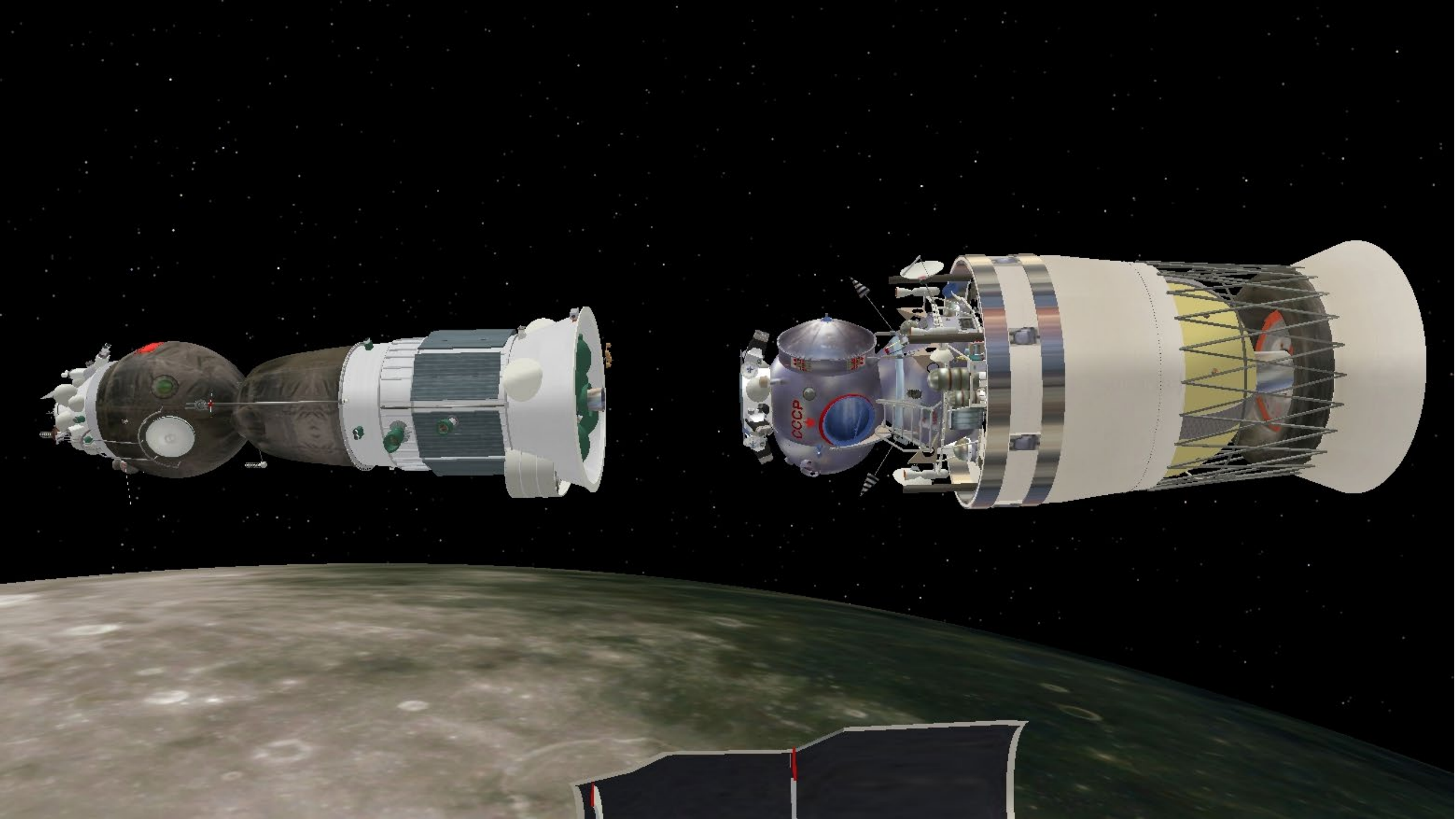
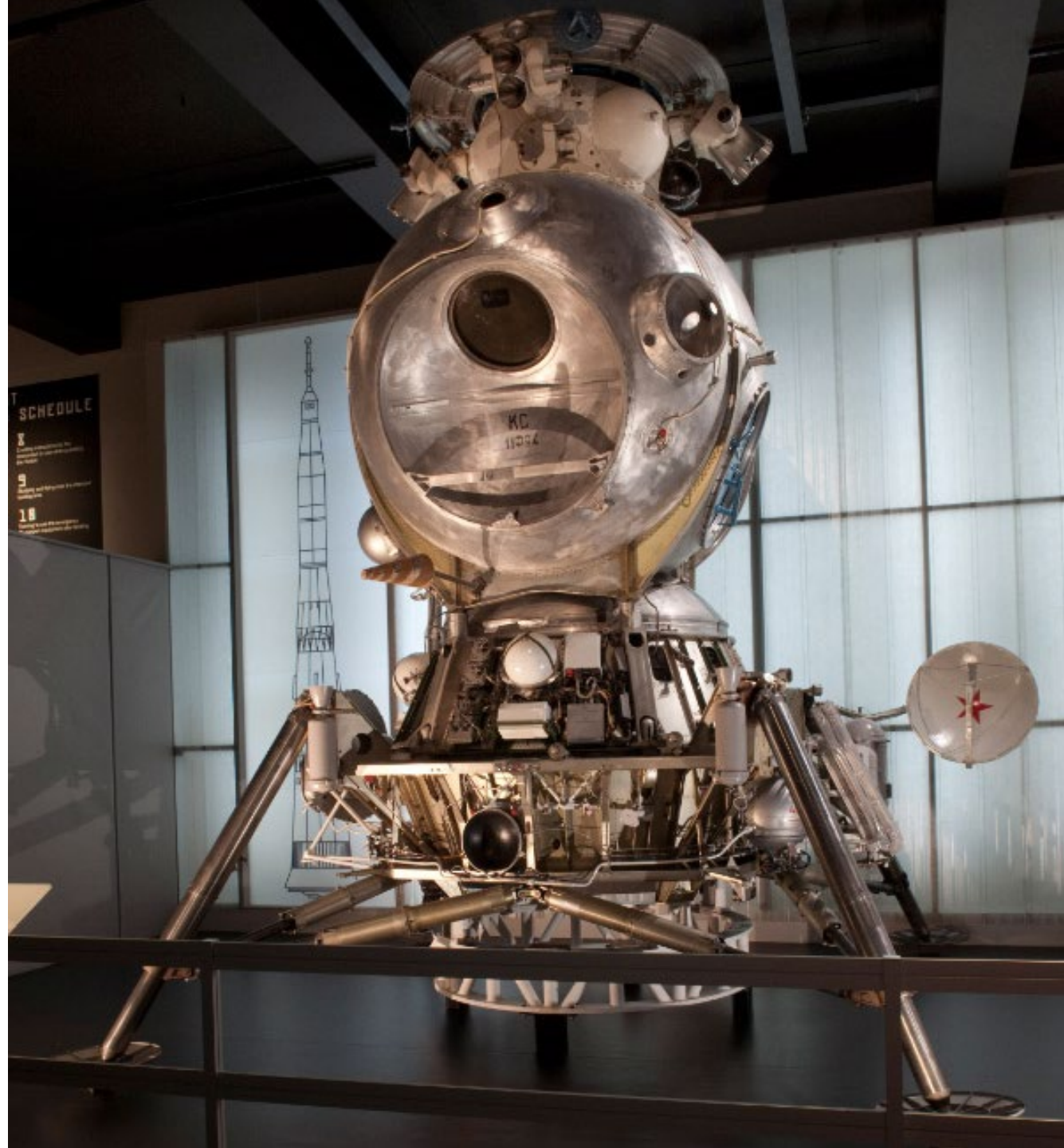

Fig. 2: LOK and LK separate









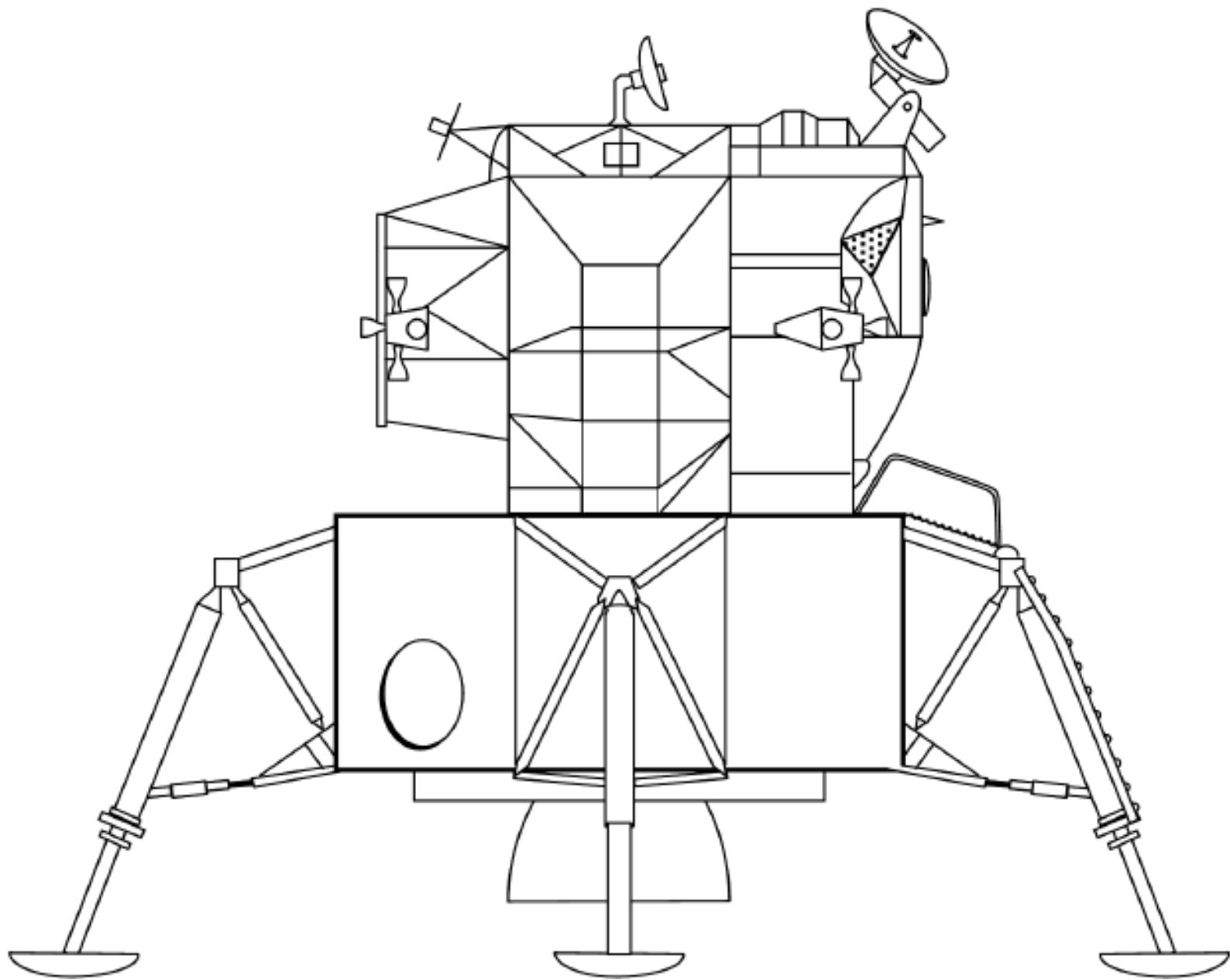
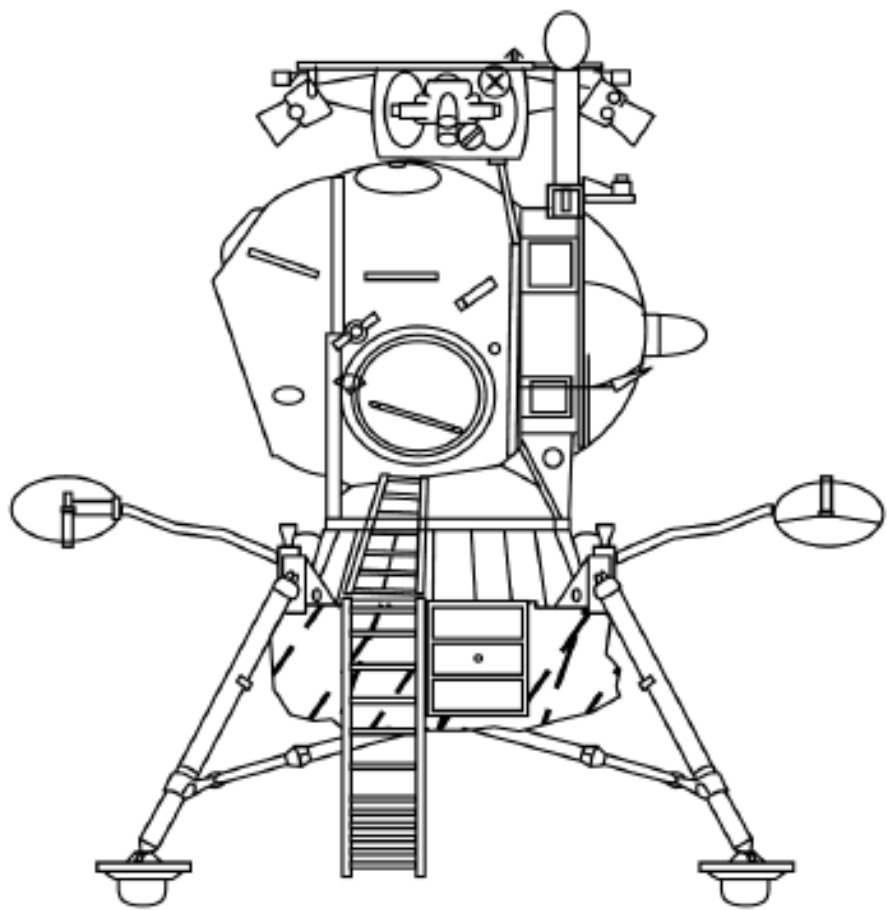



Fig. 3: LOK approaches returning LK

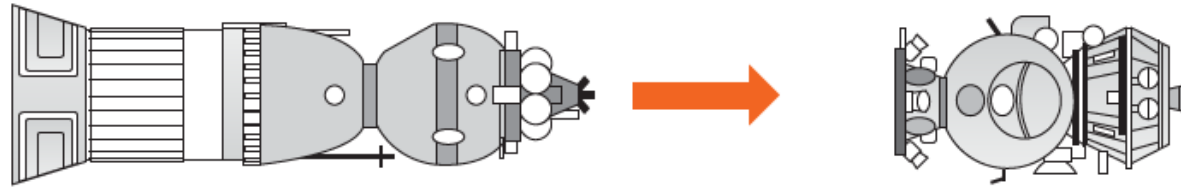

Fig. 4: Cosmonaut transfers from LK to LOK

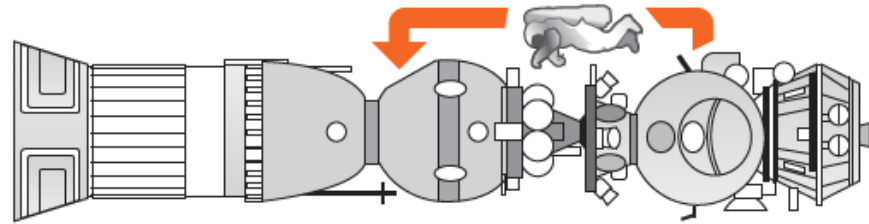
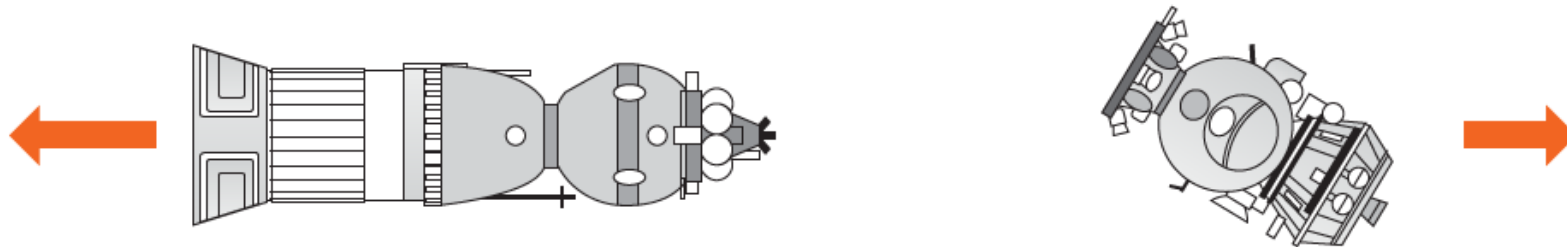
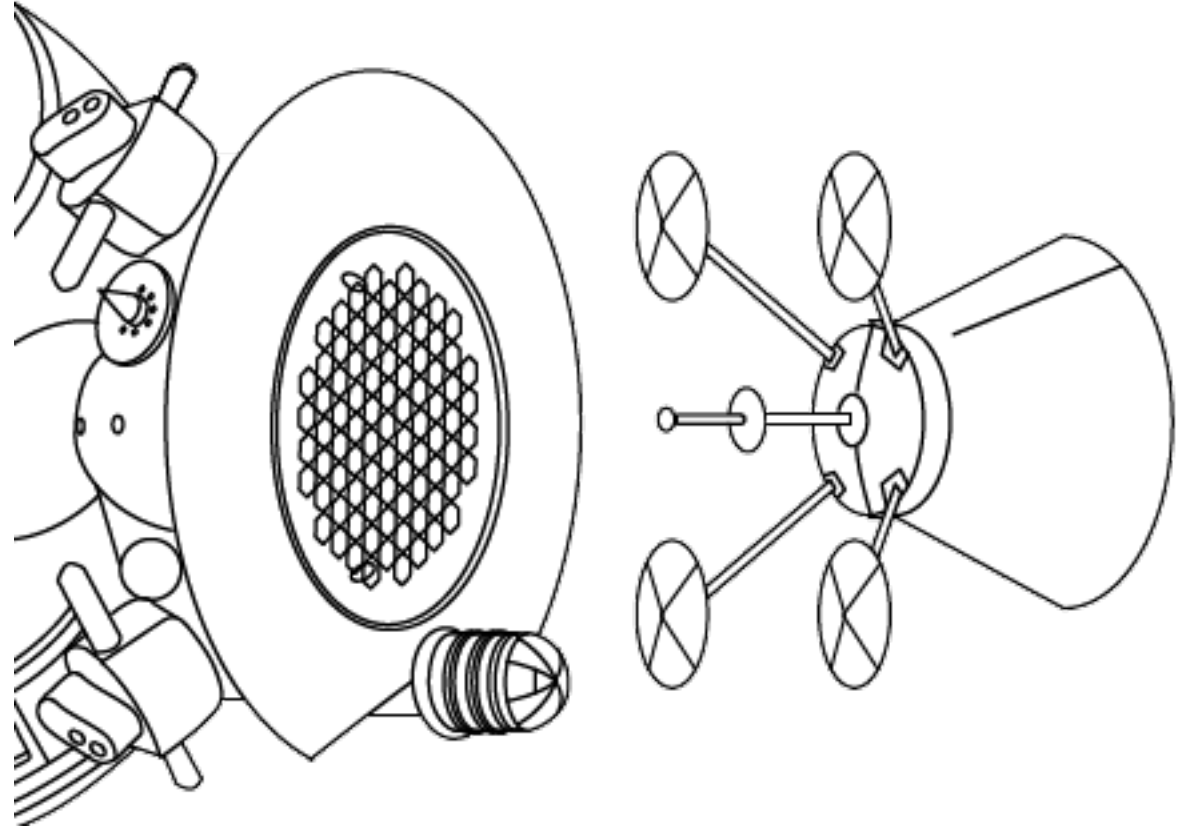
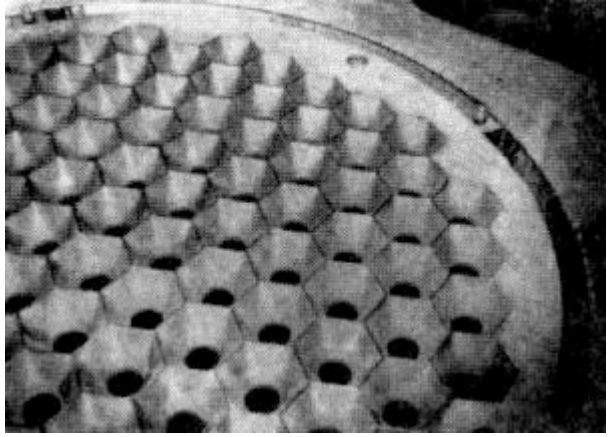
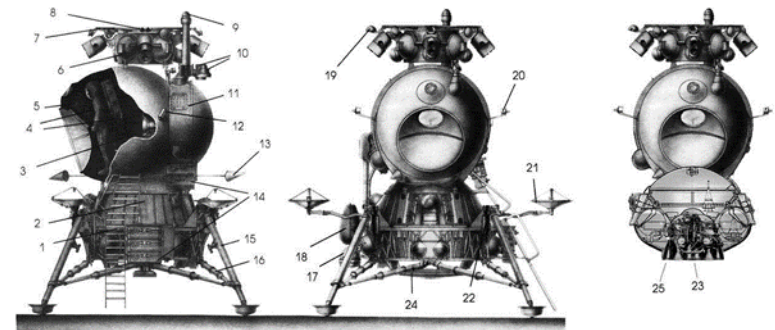
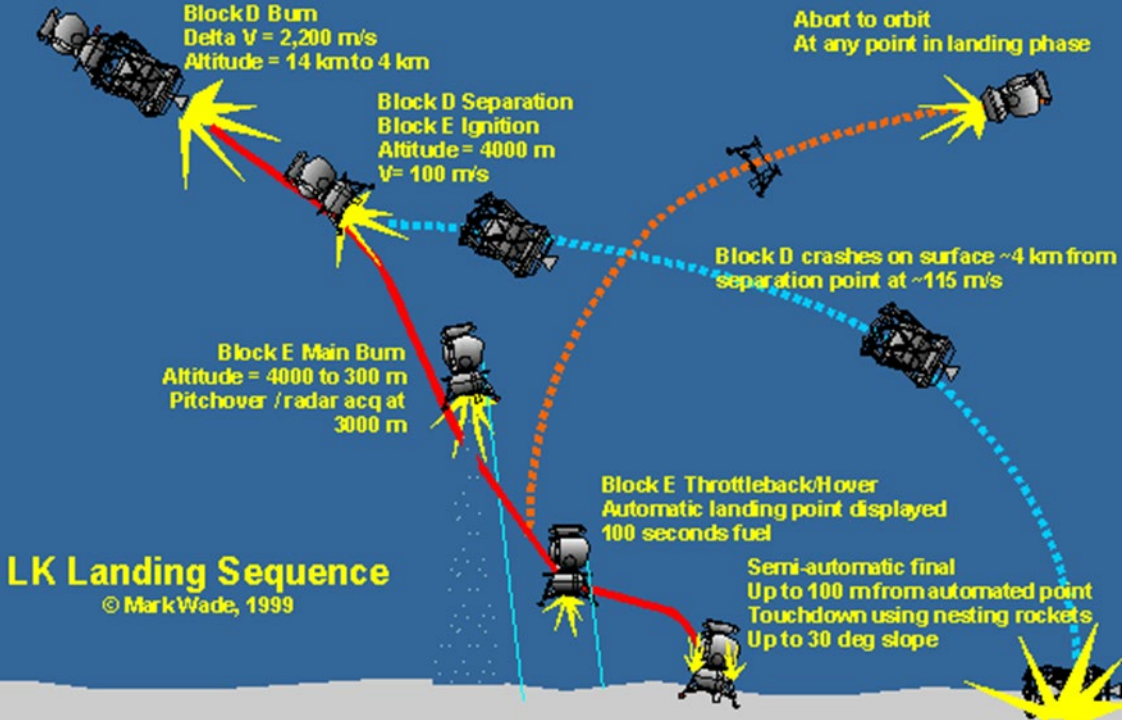

Fig. 5: LK is discarded









Landing and Surface Configuration

Ascent Configuration

- |  |  |                                |
|--|--|--------------------------------|
| 1. Lunar Landing Aggregate - LPU       | 10. Alignment Sensors                    | 19. Omni-Directional Antennas  |
| 2. Rocket Block E                      | 11. Instrumentation Compartment          | 20. Rendezvous System Antennas |
| 3. Cosmonaut Cabin                     | 12. TV Camera                            | 21. TV Antennas                |
| 4. Life Support System Equipment       | 13. Omni-Directional Antennas            | 22. Pressing Engine            |
| 5. Visual Observation Port For Landing | 14. Power Supplies                       | 23. Main engine                |
| 6. Block Of Attitude Control Engines   | 15. Support Leg With Shock Absorber      | 24. Reflector                  |
| 7. Thermal Control System Radiator     | 16. Strut With Shock Absorber            | 25. Backup Engine              |
| 8. Docking Mechanism                   | 17. Landing Radar Locator                |                                |
| 9. Targeting Sensor                    | 18. Strap-On Instrumentation Compartment |                                |

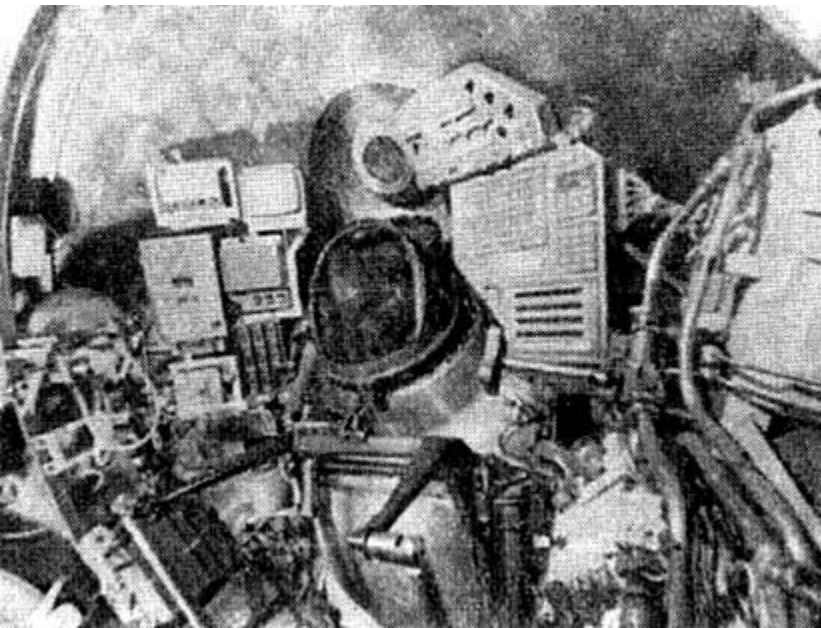



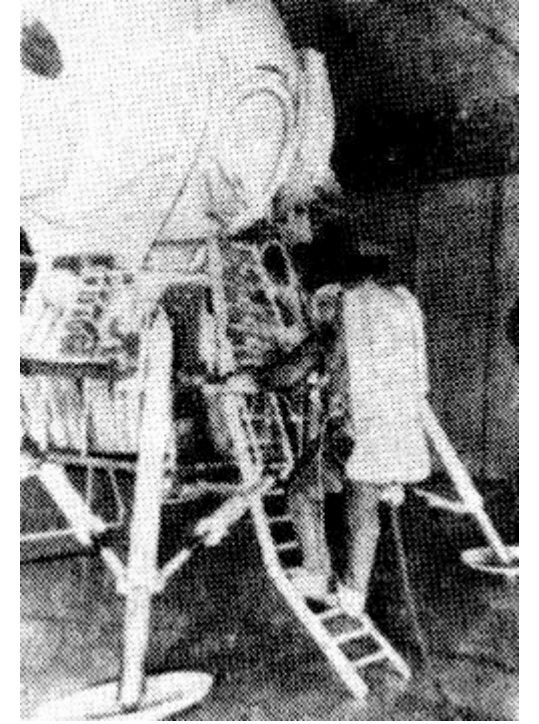
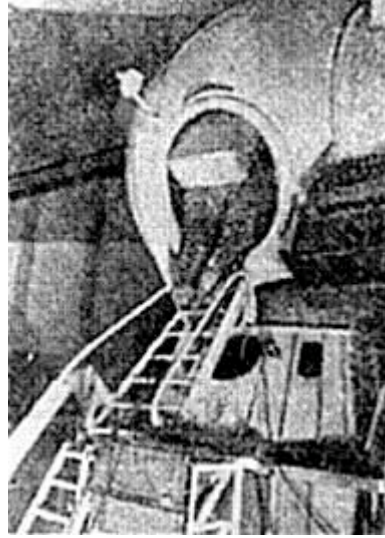

# Lunar Landing Program Flights



- Feb 1969 Uncrewed N1 test (first stage failure)
- Jul 1969 Uncrewed N1 test (first stage failure, destroyed launch pad)
- Nov 1969 Uncrewed Block D test (first stage failure)
- Nov 1970 Cosmos 379: Uncrewed LK test
- Dec 1970 Cosmos 382: Uncrewed Block D test
- Feb 1971 Cosmos 398: Uncrewed LK test
- Jun 1971 Uncrewed N1 test (first stage failure failure)
- Aug 1971 Cosmos 434: Uncrewed LK test
- Nov 1972 Uncrewed N1 test (first stage failure)

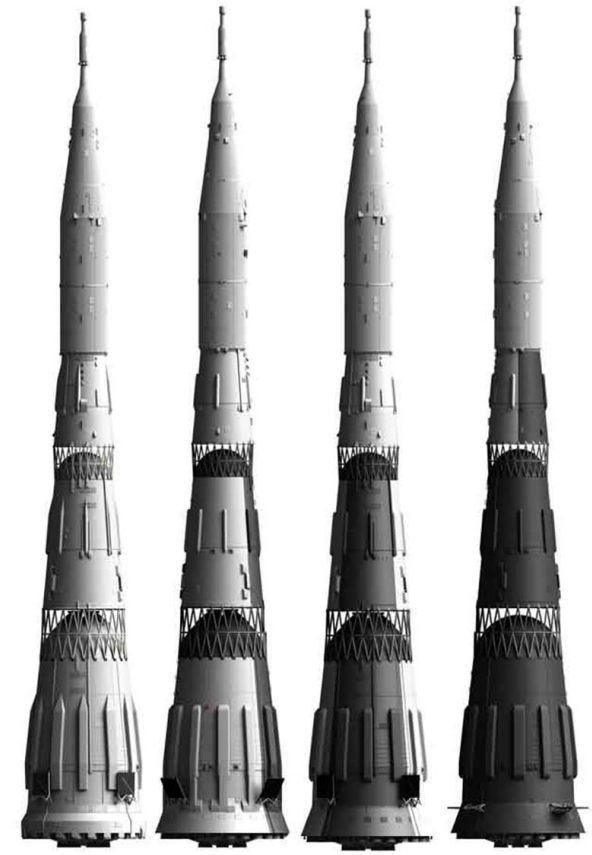

# Discussion Groups

- Siddiqi Chapter 15 (“Final Lap to the Moon”)
  - The Soviet space program between Apollo 1 and Apollo 11
- **Chertok Chapter 3 (“N1-L3 Lunar Program Under Korolev”)**
  - **The origins of the Soviet lunar landing program**
- Chertok Chapter 10 (“1969—The First N-1 Launch”)
  - The first attempt to launch the Soviet moon rocket
- The Engines that Came in from the Cold video
  - The rebirth of the N1’s engines in American rockets